



ITEM # \_\_\_\_\_

MODEL # \_\_\_\_\_

NAME # \_\_\_\_\_

SIS # \_\_\_\_\_

AIA # \_\_\_\_\_

## Planetary Mixers Planetary Mixer, 5 lt - Electronic with Hub - Black color



**603797 (DMX5BLCK)**

Dmix planetary mixer - red, 5 liters, bowl detection device, electronic variable speed with K type accessory hub. Equipped with stainless steel semi spiral hook, paddle and whisk and highly resistant safety screen - BPA free - black

### Short Form Specification

Item No. \_\_\_\_\_

Suitable for all kneading, blending and whipping operations. Metal body and large base for complete stability. 5,5 liters capacity 18/10 (AISI 304) stainless steel bowl with 2 handles. Universal motor with electronic speed variation from 40 to 240 rpm (planetary movement), driving the whisk up to 500 rpm. Removable/transparent solid safety screen - made of a bisphenol-A free (BPA) copolyester - activates the raising and lowering of the bowl. Bowl detection device allows the mixer to switch on only when the bowl and the safety screen are properly installed and positioned together. Equipped with accessory drive hub type k (accessories are not included). Supplied with 3 stainless steel tools: semi-spiral hook, paddle and whisk. Black color.

APPROVAL: \_\_\_\_\_

### Main Features

- Small, compact planetary mixer designed to whisk and mix, providing also good kneading results.
- Maximum capacity (flour, with 60% of hydration) 0,75 kg.
- Electronic speed variator.
- Removable safety screen activates the raising and lowering of the bowl.
- Delivered with:
  - Paddle, Semi-spiral Hook, Wire Whisk and Mixing Bowl for 5,5 lt
  - K type accessory drive hub (accessories are not included)
- Tools shape and size perfectly adapt to the bowl for uniform mixing of even small quantities.
- Bowl detection device allows the mixer to switch on only when the bowl and the solid safety screen are properly installed and positioned together.

### Construction

- Transparent solid safety screen made of Eastman Tritan™ copolyester BPA free, impact resistant and stays clear and durable after several dishwashing cycle. Eastman&Tritan are trademarks for Eastman Chemical Company.
- Power: 500 Watts.
- Variable speed from 40 to 240 rpm (planetary movement), to adjust to the selected tool and mixture hardness.
- Variable speed rotation of the tools from 84 rpm to 500 rpm.
- Water protected planetary system (IP55 electrical controls, IP34 overall machine).
- Universal powerful motor with high start-up torque and overload protection.
- Compact design.
- Semi-spiral hook, paddle and wire whisk in stainless steel.
- 304 AISI stainless steel bowl with 2 handles - 5,5 lt capacity.

### Included Accessories

- 1 of Stainless steel bowl with handles 5 lt PNC 653754
- 1 of Stainless steel semi-spiral hook 5 lt PNC 653755
- 1 of Stainless steel paddle 5 lt PNC 653756
- 1 of Stainless steel whisk 5 lt PNC 653757

### Optional Accessories

- 60 mm meatmincer for attachment type K (12 mm square hub) and 1 disc PNC 653043
- 3 discs (3-4,5-8 mm) for meatmincer PNC 653044

Planetary Mixer, 5 lt - Electronic with Hub - Black color



## Planetary Mixers Planetary Mixer, 5 lt - Electronic with Hub - Black color

- Pasta kit accessory (lasagne 142,5mm) PNC 653296
- Pasta kit accessory (spaghetti 2mm) PNC 653298
- Pasta kit (lasagne, tagliatelle, tagliolini) PNC 653300
- Stainless steel bowl with handles 5 lt PNC 653754
- Stainless steel semi-spiral hook 5 lt PNC 653755
- Stainless steel paddle 5 lt PNC 653756
- Stainless steel whisk 5 lt PNC 653757



Planetary Mixers  
Planetary Mixer, 5 lt - Electronic with Hub - Black color  
The company reserves the right to make modifications to the products  
without prior notice. All information correct at time of printing.

2024.03.21



## Planetary Mixers Planetary Mixer, 5 lt - Electronic with Hub - Black color

Front

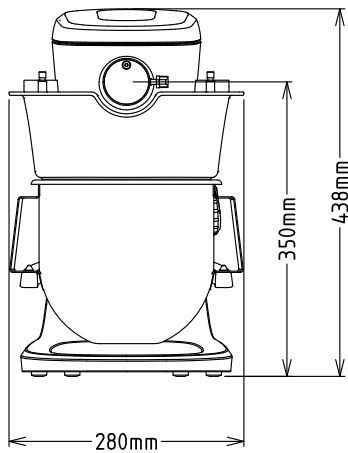

Side

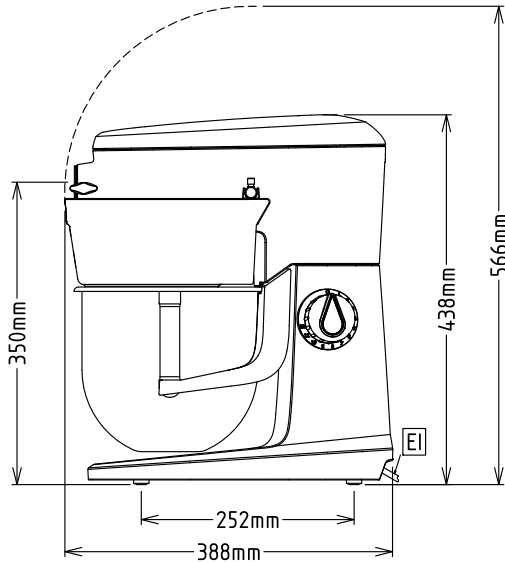

EI = Electrical inlet  
(power)

Top

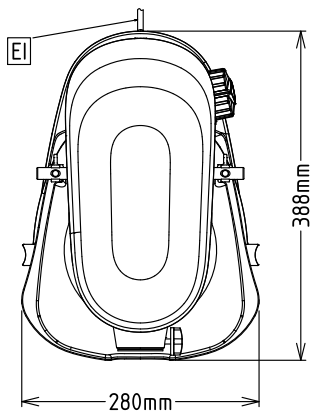

Electric

**Supply voltage:**

**603797 (DMX5BLCK)**

200-240 V/1N ph/50/60 Hz

**Total Watts:**

0.5 kW

**Capacity:**

**Performance (up to):**

0.75 kg/Cycle

**Capacity:**

5.5 litres

**Key Information:**

**External dimensions,**

**Width:**

280 mm

**External dimensions,**

**Depth:**

388 mm

**External dimensions,**

**Height:**

438 mm

**Shipping weight:**

15 kg

**Net weight (kg):**

ISO 9001; ISO 14001

**Cold water paste:**

0.75 kg with Semi spiral  
hook

**Egg whites:**

12 with Whisk

Planetary Mixers  
Planetary Mixer, 5 lt - Electronic with Hub - Black color

The company reserves the right to make modifications to the products  
without prior notice. All information correct at time of printing.

2024.03.21